



IN-LINE CENTRIFUGAL DUCT FANS ILHT Series

ILHT/8-190 *230/400V 50*



Range of direct-driven rectangular in-line fans designed for smoke extraction in fire conditions and certified F400-120 (CE marked). All models are suitable for air stream temperature up to 80°C. The casings are manufactured from high grade robust galvanised sheet steel. Due to the flexible design and configuration the ILHT units can be installed in any position both horizontal or vertical. All fans incorporate a centrifugal backward curved impeller manufactured from galvanized sheet steel. Available, depending upon the model, with three phase motors in 4, 6, 8, 4/6, 4/8, 6/8 or 6/12 poles.

Motors

All the motors are IP55, Class F insulation.

Electrical supply:

-Three phase 230/ 400V-50Hz, 1-speed motors.

-Three phase 400V-50Hz, 2-speed motors.

(See characteristics chart).

Speed controllable by inverter.

On request

Single phase motors.

Speed controllable motor by voltage (ILHB/4-035, ILHB/6-035, ILHB/6-050 and ILHB/6-060).

Double thickness (double skin) panels internally lined with sound and thermal fibre glass insulation (25 mm).

+ Attributes



Easy to install

Fixings fitted to ease the installation.

+ Acoustic characteristics

Unfortunately an error occurred.

''

+ Technical characteristics

Unfortunately an error occurred.

''

+ Dimensions

Unfortunately an error occurred.

11

+ Curves

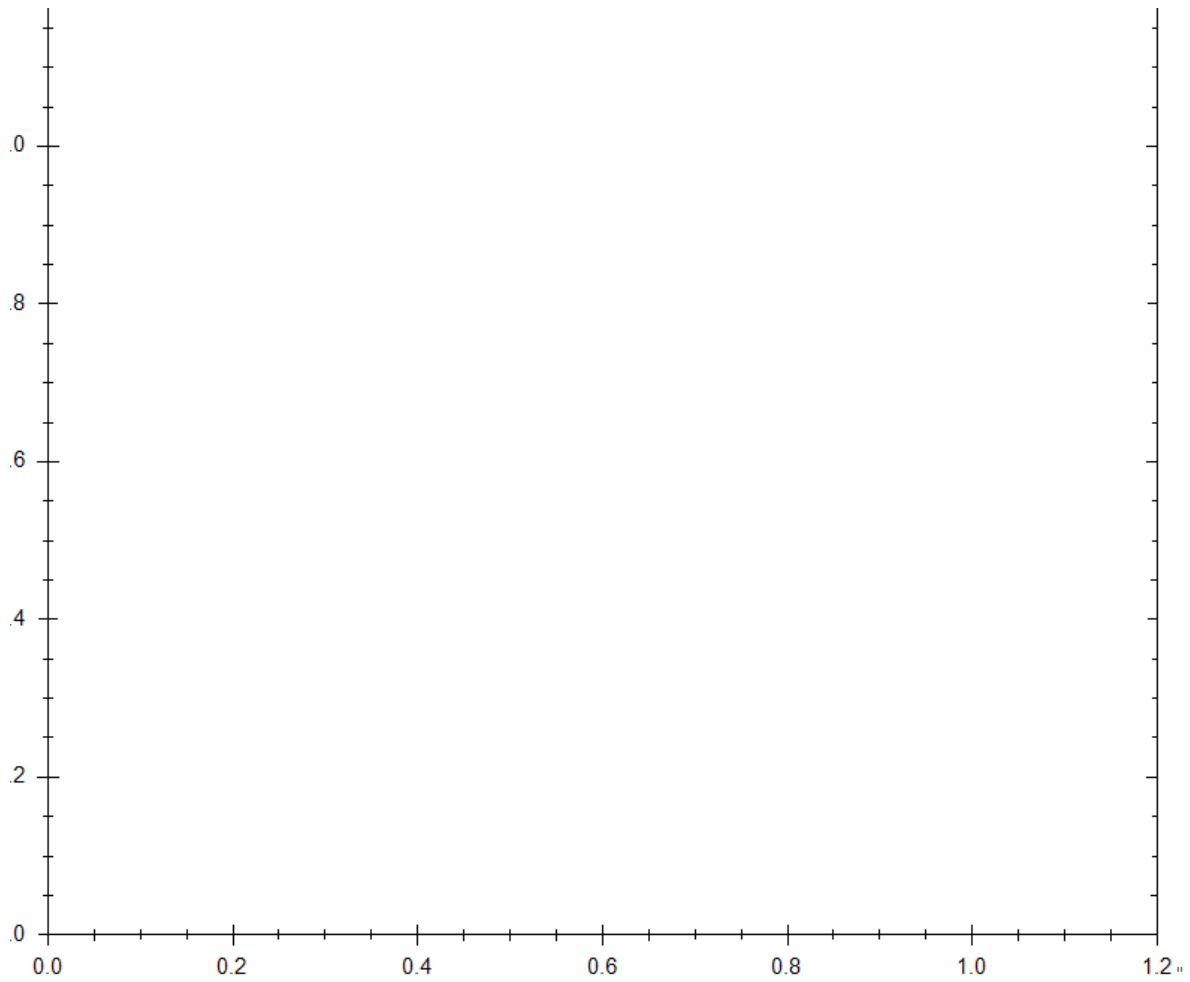

+ Configuration

Versatile design

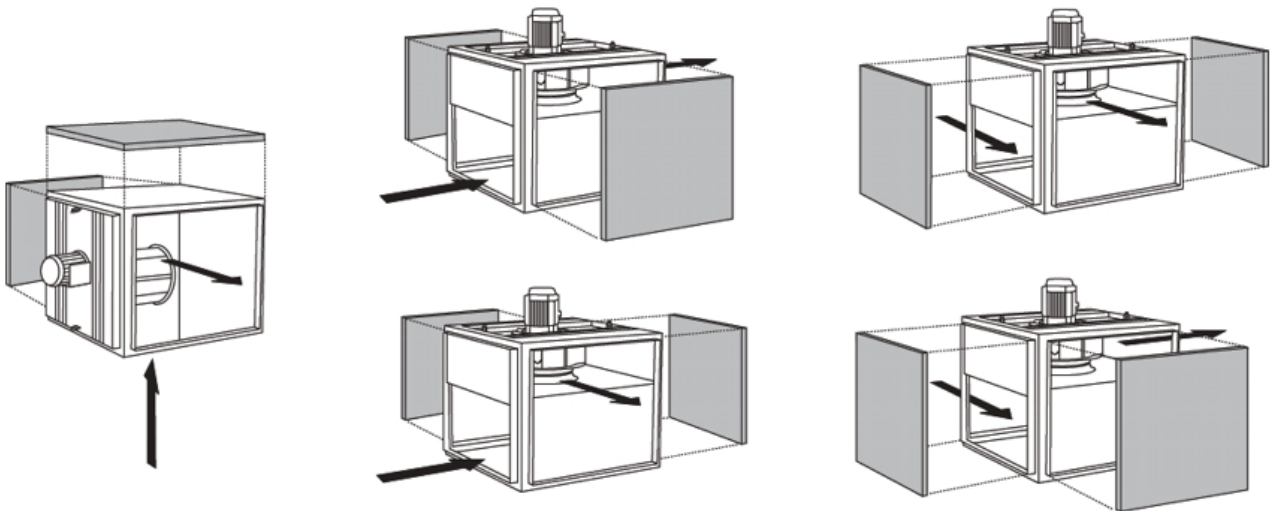

Interchangeable side panels, to produce the different possibilities of air extraction and supply.

+ Mounting Accessories

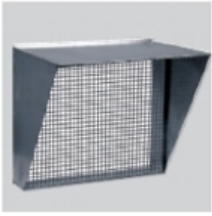

ILHT-VISERA-H
Horizontal mounted,
discharge protection
guard.



ILHT-ACOP-RECT
Flexible rectangular
flanged duct
connector.

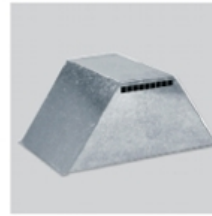

ILHT-TAPA-MOTOR-V
Motor cover.

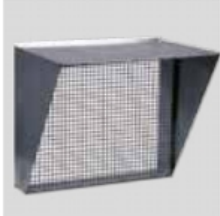

ILHT-VISERA-V
Vertical mounted,
discharge protection
guard.



ISA-ILHT
Anti-vibrations support.
(Set of 4 rubber
supports)

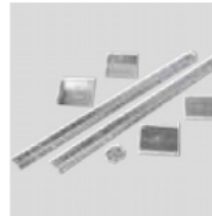

ILHT-SOPORTE
Mounting support.

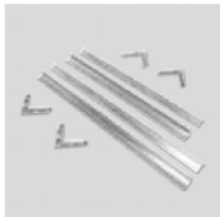

ILHT-BRIDA
Rectangular duct connection
flange.

+ Electrical Accessories



DPS 2-30
DPS 10-100
Differential pressure
switch.



INTZ
Electrical isolation
switch (can be
provided fitted on
the fan and wired).