



Centrifugal roof mounted fans **MAX-TEMP CTHB / CTHT Series - Horizontal discharge**



CTHT/6-315 (400V50HZ) VE



Range of centrifugal roof mounted fans in horizontal discharge format, designed for smoke extraction in fire conditions and certified F400-120 (CE marked) (1).

All models are suitable for air stream temperature up to 120°C.

Bases are manufactured from galvanised sheet steel and cowls are manufactured from spun aluminium.

All models incorporate bird-proof guard.

Available, depending upon the model, with single or three phase motors in 4, 6, 8, 4/8 or 6/12 poles.

(1) Except 140, 180 and 200 models.

Motors

All motors are IP55, class F and equipped with ball bearings greased for life.

Electrical supply:

Single phase 230V-50Hz.

Three phase 400V-50Hz.

(See characteristics chart).

Speed controllable by voltage, up to the model. Adjustable frequency drive from 450 to 710. When using a speed controller, the electrical installation must be equipped with a security system which allows the maximum speed of the fans in case of fire.

Additional information

140, 180, 200 and 225 models are specially recommended for extracting smoke from the fireplaces.

Only F400-120 at maximum speed fan.

+ Attributes



Easy to install
Supports easing the installation on the roof.

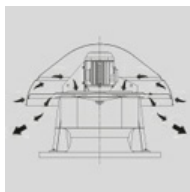

Self cooling system
Special design in order to cool the motor and to extend the life of the assembly.

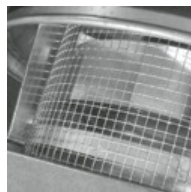

Bird-proof guard

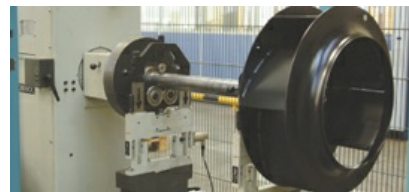

Backward curved centrifugal impellers
To prevent accumulation of dirt. Models up to 400 are manufactured from galvanised steel sheet. Models from 450 to 630 are manufactured in sheet steel protected against corrosion by cataphoresis primer and black polyester paint finish.

+ Acoustic characteristics

Unfortunately an error occurred.

''

+ Technical characteristics

Unfortunately an error occurred.

''

+ Installation

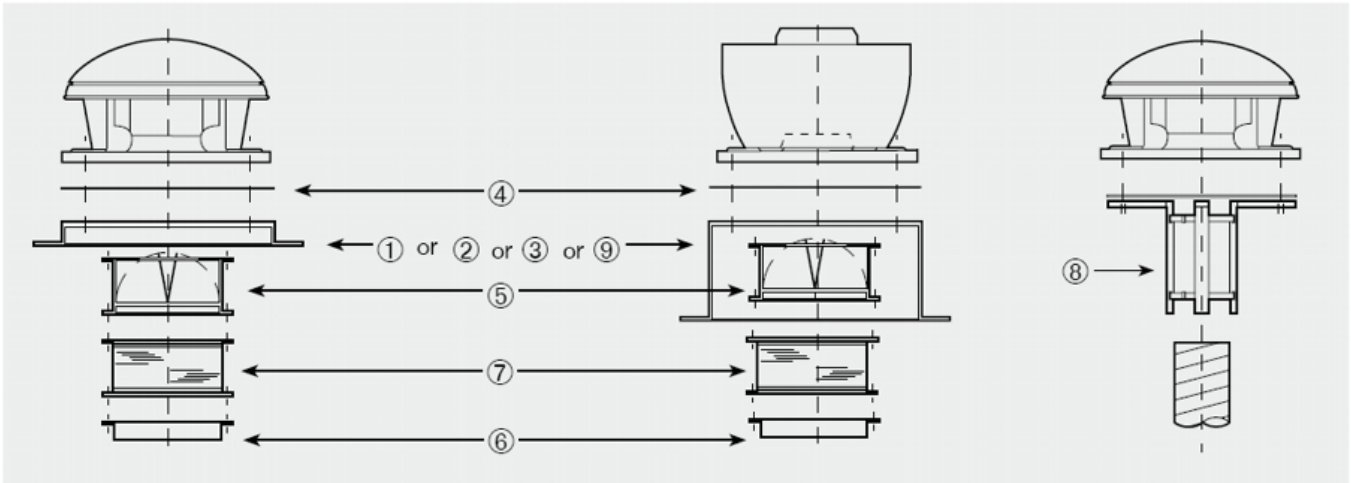

Fan model	① Sealing frame	② Flat roof insulated up stand	③ Acoustic up stand	④ Accessory adapter plate	⑤ Back draft shutter	⑥ Flange with spigot	⑦ Flexible coupling	⑧ Circular adapter	⑨ Support base for inclined curb mounted installations
140 180	JMS-300	JBS-300	JAA-300	JPA-300	JCA-300	JBR-300 N	JAE-300 N	JCC-300	BI-3
200 225	JMS-435	JBS-435	JAA-435	JPA-435	JCA-435	JBR-435 N	JAE-435 N	JCC-435	BI-4
250 315	JMS-560	JBS-560	JAA-560	JPA-560	JCA-560-N	JBR-560 N	JAE-560 N	JCC-560	BI-5
400	JMS-630	JBS-630	JAA-630	JPA-630	JCA-630-N	JBR-630 N	JAE-630 N	JCC-630	BI-6
450	JMS-710	JBS-710	JAA-710	JPA-710	JCA-710-N	JBR-710 N	JAE-710 N	-	BI-7
500 560	JMS-905	JBS-905	JAA-905	JPA-905	JCA-905-N	JBR-905 N	JAE-905 N	-	BI-9
630 710	JMS-1100	JBS-1100	JAA-1100	JPA-1100	JCA-1100-N	JBR-1100 N	JAE-1100 N	-	BI-11

+ Dimensions

Unfortunately an error occurred.

11

+ Curves

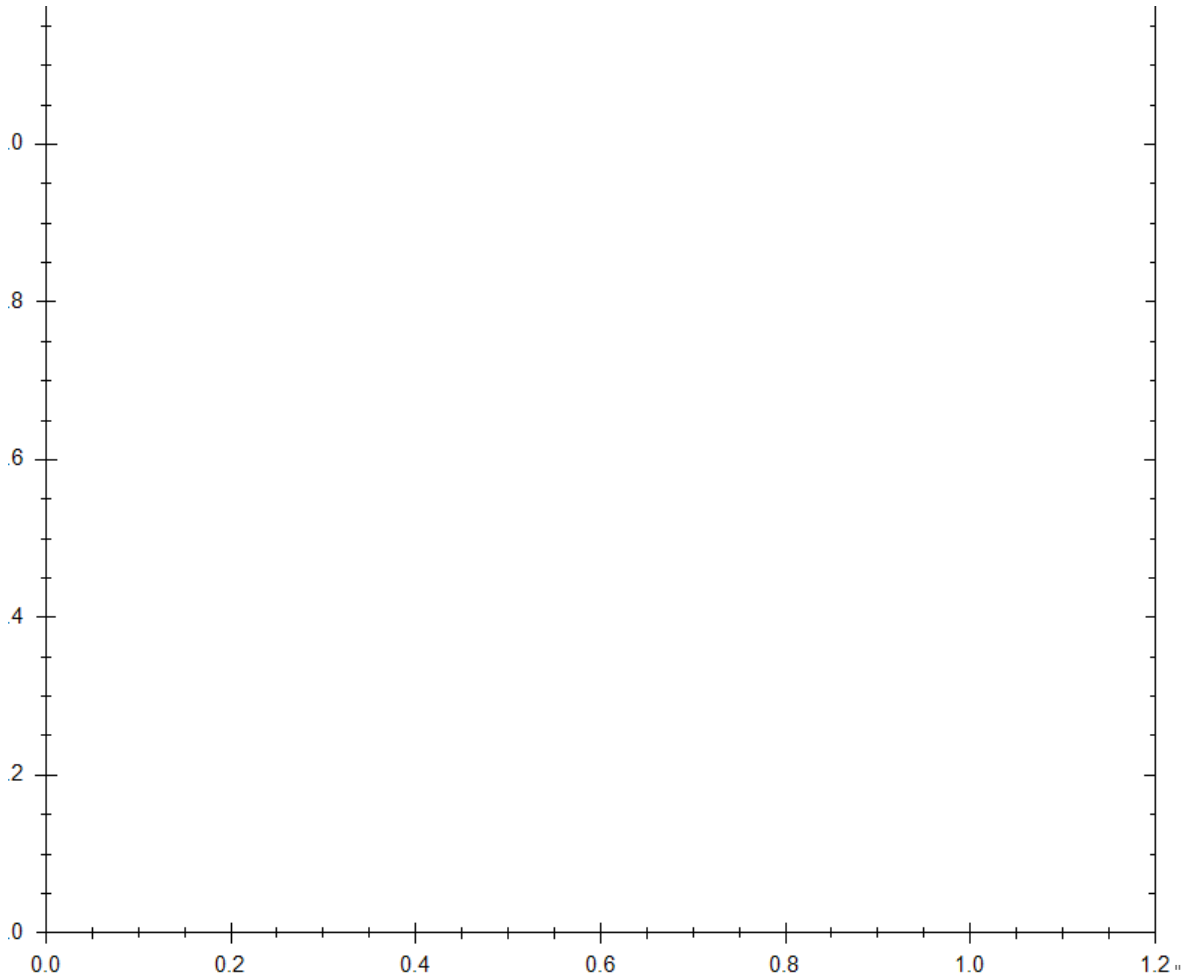

+ Electrical Accessories



REB
Single phase
electronic speed
controllers.
- For use with the
single phase roof
fans.



REB-5 / REB-10
Single phase
electronic speed
controllers.
- For use with the
single phase roof
fans phase roof
fans.



RMB / RMT
Auto transformer
speed controllers.
- For single phase
and three phase
roof fans models
from 140 to 400.



**On/ Off Electrical
isolation switch**
- Switch On/ Off 5P
(1 speed motor)
- Switch On/ Off 8P
(2 speed motor).



**COM D/S
Switch**
- To connect three
phase fans with
400 V motor.
- For three phase
roof fans models
from 140 to 400.



DEMA DH
Switch for 2-speed
motors with
Dahlander.



VFTM IP54
Adjustable
frequency
drives for three
phase motors from
0,37 to 15 kW.



VFKB IP65
Adjustable
frequency
drive for three phase
motors from 0,37 to
4 kW.

+ Specific Accessories

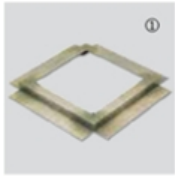

- JMS**
Sealing frame
 - For mounting a roof fan on an up stand or base.
 - Supplied with screws and gasket for a complete weatherproof seal.

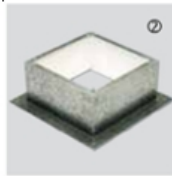

- JBS**
Flat roof up stand
 For mounting a fan on a flat roof without up stands.
 - For use on horizontal roofs.
 - Internal insulation to prevent condensation.
 - Supplied with screws and gasket for a complete weather seal.

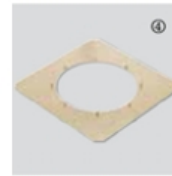

- JPA**
Accessory adapter plate
 - Used when mounting the accessories [JCA, JBR, JAE].
 - Allows the fan to be disconnected from the upstand without having to remove the duct.



- JCA / JCA N**
Backdraft shutter
 - Prevents backdraft when the fan is not operating.
 - To be mounted at the fan inlet with the JPA plate.



- JAE N**
Flexible coupling
 - Reduces the transmission of vibrations when the duct is connected directly to the fan.
 - To be mounted at the fan inlet with the JPA plate.



- BI**
Support base for inclined curb mounted installations
 - To ensure a proper installation of the MAXTEMP roof fan it is essential to specify the roof pitch angle and the distance between the roof beam profiles.



- JBR N**
Flange
 - For use when circular connection is required directly to the fan.
 - To be mounted at the fan inlet with the JPA plate or fixed directly to the fan base [rivets or screws not supplied].



- JCC**
Adapter for circular duct
 - For use when fitting the models up to 400, directly to a spirally wound circular duct.



- JAA**
Acoustic up stand
 - Reduces in duct and radiated noise.
 - For use when mounting a fan flat roof without up stands.
 - Supplied with screws and gasket for a complete weather seal.