



CENTRIFUGAL SINGLE INLET FANS

CMB / CMT Series

CMT/2-225/090 2,2KW
(230/400V50HZ)LG VE



ATEX versions

On request, explosion proof versions in accordance with ATEX Directive, for 3 phase models.

For ambient working temperatures from -20°C to +40°C.

- ATEX Flameproof - Gas

⊕ II 2G Exd IIB T4

⊕ II 2G Exd IIB+H2 T4 (with Ex d IIC T4 motor)

- ATEX Increased safety - Gas

⊕ II 2G Ex e II T3

- ATEX - Dust

Suspended flammable particles and non-conductive dust:

⊕ II 3D Ex tc IIIB T125°C

Conductive dust:

⊕ II 3D Ex tc IIIC T125°C (with IP65 motor)

To select CMT ATEX refer to performance curves, or Easyvent.

Note electrical data may vary for ATEX motors.

For single phase models, please consult S&P."



Range of centrifugal single inlet fans suitable for continuous extraction of airstreams temperature up to 80°C or 110°C (Series 1) or 150°C (Series 2 and 3). All casings are manufactured from electro-welded sheet steel protected against corrosion by grey epoxy-polyester paint coating.

All models incorporate forward curved centrifugal impellers manufactured from galvanised sheet steel. Available, depending upon the model, with single or three phase motors in 2, 4 or 6 poles.

Motors

All motors are IP55, Class F (1) with ball bearings greased for life.

Electrical supply:

-Single phase 230V-50Hz.

-Three phase 230/400V-50Hz up to 3kW.

-Three phase 400V-50Hz, for higher power motors.

Series 1 are equipped with B14 flange mounted motor.

Series 2 & 3 are equipped with B3 foot mounted motor.

(1) Series 1: Some motors are IP44, Class B

Additional information

The scroll can be orientated in 8 different positions as per the table below.

Standard supplied position: LG 270.

+ Attributes

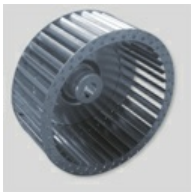

Impeller dynamically balanced

Forward curved centrifugal impellers dynamically balanced, according to ISO 1940 standard, providing vibration free operation.

+ Acoustic characteristics

Unfortunately an error occurred.

+ Technical characteristics

Unfortunately an error occurred.

+ Orientation

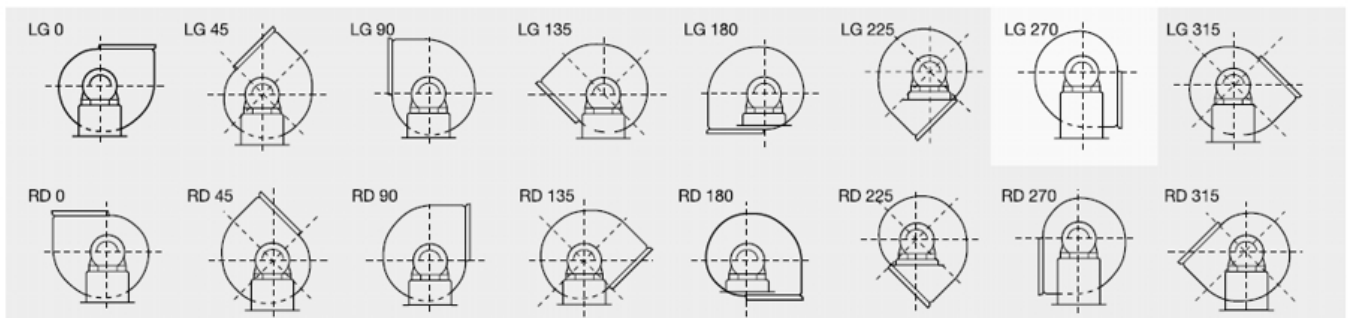

LG 270 standard supplied position. Special versions of RD configuration can be supplied under request.

+ Dimensions

Unfortunately an error occurred.

11

+ Curves

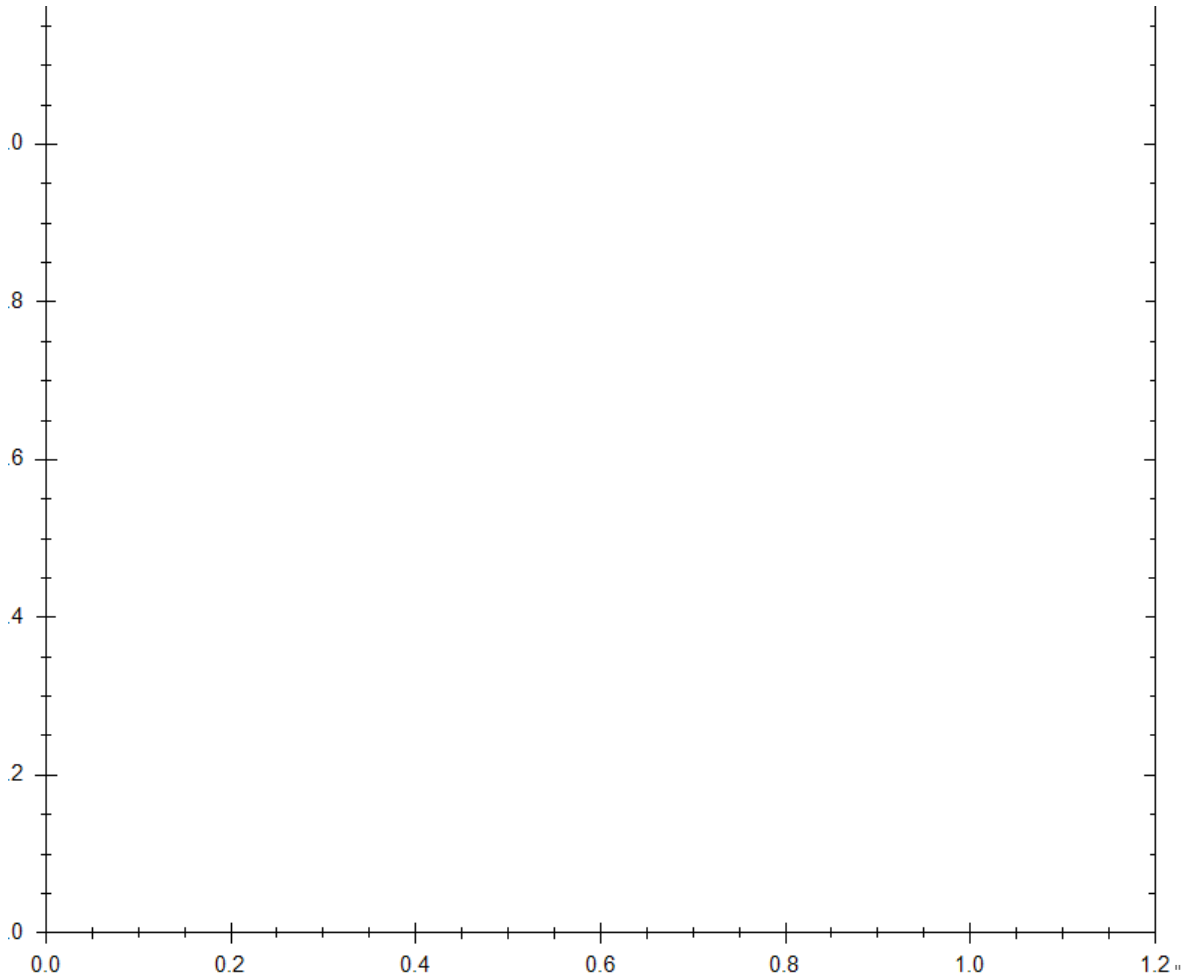

+ Mounting Accessories

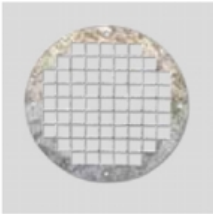

KRJ
Inlet guard.

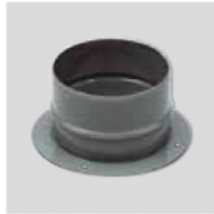

KBA
Inlet flange.



KBD
Discharge flange.



ACOPEL F400 N
Circular flexible connector.
Certified F400-120.
Can be installed at the inlet or outlet side.



KAD
Rectangular flexible connector.



KSE
Anti-vibration mounts.



KMTA
Sound attenuators for mounting at the CMT fan inlet.



KMTI
Sound attenuators for mounting at the CMT fan outlet.

+ Electrical Accessories



REB
Electronic single phase speed controllers.



RMT
Three phase auto transformer speed controllers.



VFTM TRI IP54
Adjustable frequency drive for three phase motors from 0,37 to 15 kW 400 V.

+ Specific Accessories

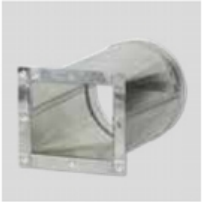

KMBI
Rectangular/circular connection flange for mounting at the CMT fan outlet.

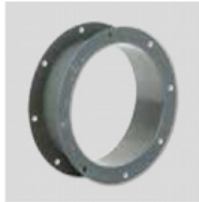

KMBD
Double connection flange for mounting at the CMT fan inlet.



KRJ
Inlet guard.